

STOLL



**A NEW ERA
OF FRONT
LOADERS.**

**ProfiLine
ISOBUS Connected**

ISOBUS FUNCTIONS.

- Ultimate Performance
- Premium Comfort
- Faster connectivity



The unique STOLL ProfiLine ISOBUSConnected features take front loader and tractor work to a new level of comfort, user-friendliness and precision.

BENEFITS

The new STOLL ProfiLine ISOBUSConnected brings the full integration of the front loader into the tractor system. The new system settings, new level of comfort and higher safety standards.

The ISOBUS standard unifies the communication between the tractor and the new Stoll's front loader. Thanks to it ISOBUSConnected front loader can be fully integrated into the tractor.

With the STOLL ProfiLine ISOBUSConnected, the front loader can be connected to the tractor control unit and operated by the tractor joystick and terminal

In addition to the electro-hydraulic parallel levelling on the FS model, the new STOLL ProfiLine ISOBUSConnected system also offers professional functions that turn the tractor with the Stoll front loader into a true professional machine.

12 UNIQUE FUNCTIONS OF PROFILINE ISOBUSCONNECTED

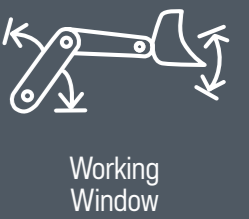
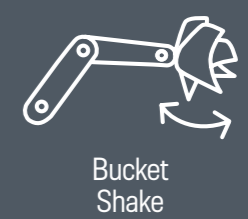
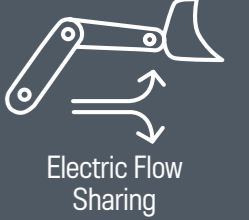
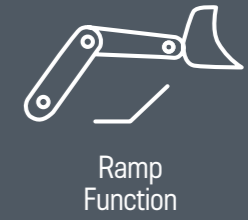
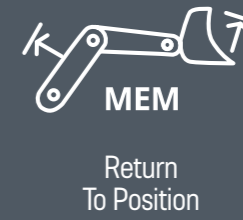
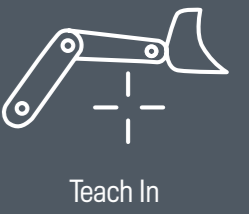
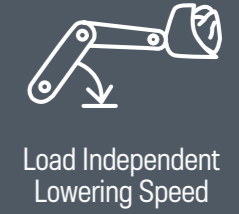

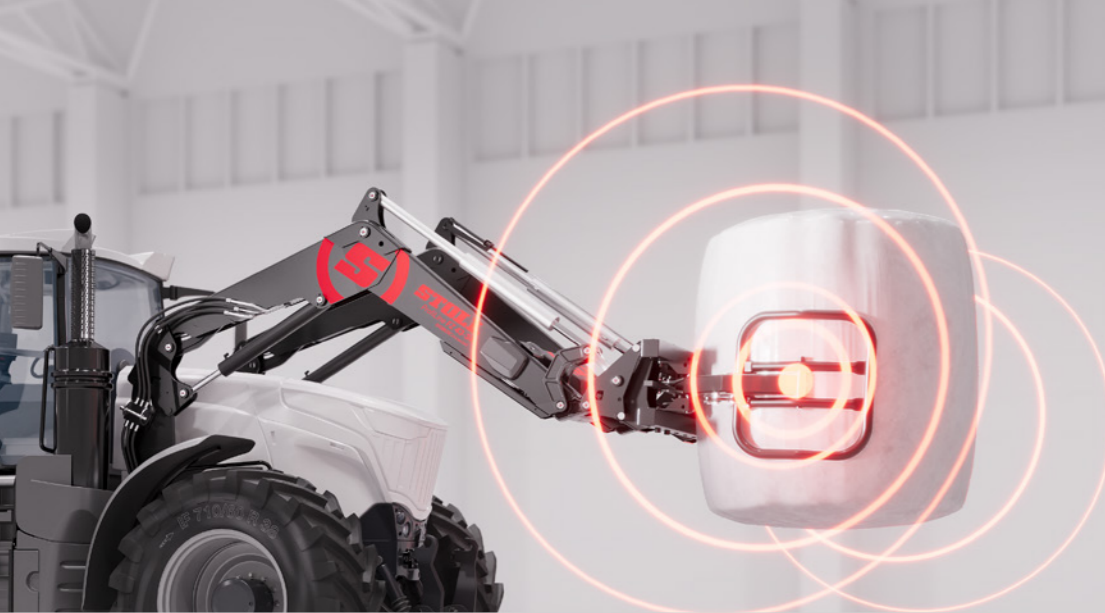

FUNCTION 1

PRESSURE REGULATION



Overload protection implement
Pressure regulation
Machine overload protection

Pressure limitation on the bale grab application

This function enables the convenient and protective use of a bale grab and protects the plastic wrapping from damage, as the clamping force can be individually adjusted by pressure limitation. The control unit regulates the pressure in the 3rd function via the valve to a previously defined value.

Pressure relief function, e.g. for a motorised drive

This function prevents overloading, e.g. due to jamming of a hydraulic actuator. If the pressure exceeds a previously defined value, the valve is regulated back so that the defined pressure range is maintained.



FUNCTION 2

LOAD INDEPENDENT LOWERING SPEED



Controlled lowering
Load independent
Maximum comfort

Load independent lowering

The same lowering and lifting speed regardless of the load.

The lowering speed is reduced by throttling at the return side. Due to the rigid design, the return throttling is too high without load and unnecessary power loss occurs; with load it is too low and the lowering speed is too high. The automatic adjustment of the return oil adapts to the weight of the implement and the speed remains stable regardless of the load. The speed corresponds to the preselection by the joystick deflection. (Up-down same speed, on/off function).



FUNCTION 3

TEACH IN



Defined movement sequence
Simple operation
More power

Programmable movement sequences

When the teach-in function is switched on, a movement sequence is saved. A complete movement cycle can be saved by running through it. When activated, the liftarm and the tool are controlled accordingly. This movement cycle for the liftarm and implement is repeated accordingly when activated.

Settings: Define, save and call up the movement cycle..



FUNCTION 4

RETURN TO POSITION



Faster work
Precise, recurring position
Stress-free working

Return to Position

The operator defines a position to be approached. The position is approached by moving the boom and implement. The set position is saved and is approached automatically. To simplify recurring sequences, two positions, an upper and a lower position can be approached with a simple signal (pressing a button and moving the joystick).

Readjustment using the joystick is not necessary. In independent mode, the saved position of the liftarm and implement can be approached separately. In linked mode - the saved position of both the liftarm and implement will be approached.

The return to position is an on/off function.



FUNCTION 5

RAMP FUNCTION



Load-independent
Adjustable response behaviour of the front loader
High power

Adjustable Response Behaviour

The aim is to increase comfort and enable material-friendly working. In order to meet the needs of the operator, the response behaviour can be defined independently and flexibly. The response behaviour defines the time from the joystick deflection to the full deflection of the control spool.

The start time and stop time are different;
Load A and B start time, load A and B stop time. The times can also be defined as a function of the load.
The response behaviour is thus optimally adapted to the current work situation.

Settings: Response behaviour, without weight dependency (four parameters).



FUNCTION 6

ELECTRIC FLOW SHARING



Priority control
Adjustable
Smooth switching

Electronic volume splitting

The maximum possible pump volume is determined by the speed and displacement of the pump. If the desired volume flow is higher via the control of the valve segments, the volume of the controlled consumers is reduced proportionally so that the inflow volume and the pump volume are equal.

Priority functions possible

It can be defined that the volume flow is not reduced for defined functions. A disproportionate volume flow reduction is also possible (on/off function).



FUNCTION 7

END POSITION DAMPING



Load dependent
Protection of the machine
Improved comfort

End Position Damping

The aim of end position cushioning is to avoid a hard impact in the end position of the cylinder. A reference delay is calculated depending on the speed of the consumer. With this function, the approach to the end position is gentle yet dynamic.

Sharp braking when reaching the end positions can be prevented. The hard impact on the driver and the load on the material is avoided by calculating the kinetic energy and determining the required deceleration distance.

The protection of the material and the improved driving comfort of this on/off function is adjustable and therefore always guaranteed.



FUNCTION 8

BUCKET SHAKE



Adjustable frequency
Clean emptying
Work efficiency

Complete emptying.

If material gets stuck in the bucket, the shaking function can be activated. The bucket is moved back and forth quickly and the material falls out.

The duration can be adjusted. The amplitude is determined by the deflection of the joystick. The vibration function can also be provided with a decaying amplitude.

The bucket moves horizontally or to a defined position. Then the blade moves up and down with smaller amplitudes.

The setting of the frequency depends on the load of the material properties. The amplitude correlates with the deflection of the joystick of this on/off function.



FUNCTION 9

WORKING WINDOW



Operator defined working range
Reduced risk of accidents
Improved manoeuvrability

Working area

The aim is to adjust the end strokes electronically in order to avoid collisions or facilitate manoeuvrability. The permissible movement range of the front loader is determined by the electrical upper and lower end stroke.

It is possible to define:

- upper position
- lower position
- both positions together

The possible movement range of the front loader is now limited within the defined range (on/off function).



FUNCTION 10

VIBRATION DAMPING



Load independent
Adjustable
Switchable

Vibration Damping

Reduces the movement of the vehicle on uneven road surfaces. The implement is used as a mass absorber by means of a switchable accumulator. The switchable accumulator dampens the vibrations of the vehicle body accordingly.

The vibration dampening reduces the movement of the implement, which transmits shocks to the implement due to uneven road surfaces. The implement is isolated from the bodywork by the vibration damping.

The dampening of the system can be adjusted. The amount of oil flow depends on the valve opening and is adjusted via the regulator.

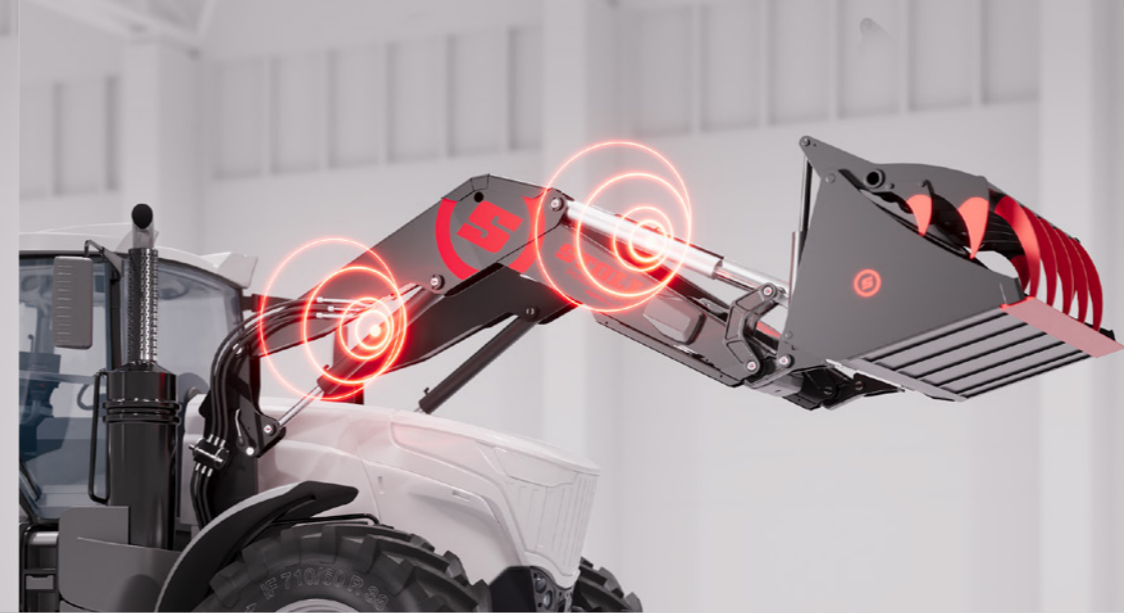

FUNCTION 11

WEIGHING



Flexible position for weighing
Travelling and weighing
High accuracy

Weighing

Each implement is calibrated once and the corresponding data is saved. The attached implement can be selected accordingly by the operator. When the operator presses the button and the loader is in the measuring range (weighing range), the weighing process is started and the weight is calculated based on the pressure and geometry data.

The result is shown on the display. The accuracy is $\pm 1\%$ (of the max. weight). If several weighing processes are carried out, the weighing results can be added together automatically (total weight).

A total weight can be entered, which is automatically subtracted and the required "remaining weight" is automatically calculated and displayed. The loader must be stopped, before the weighing process can be carried out.



FUNCTION 12

ELECTRIC HYDRAULIC PARALLEL LEVELING



Fewer mechanical components
Highest precision
Rapid dump function for quick emptying

Electric Hydraulic Parallel Leveling (available only for FS loaders)

With parallel guidance, the implement is automatically held in the defined position when the front loader is moved up and down. The angle to the ground is automatically corrected so that the position of the implement in relation to the ground remains the same.

The movement of the boom cylinder is determined by the deflection of the joystick. The angle of the implement is calculated and adjusted accordingly with very high accuracy when the boom is raised or lowered.

The function can be switched on and off.

ISOBUSCONNECTED SPECIFICATION.

The new era of front loaders is here. **STOLL ProfiLine ISOBUSConnected** ensures maximum integration of the loader into your tractor.

SMARTER. FASTER.

TECHNICAL DATASHEET

PROFILINE NEXT GENERATION ISOBUSCONNECTED				SIZE 2				SIZE 3				SIZE 4				SIZE 5				SIZE 6			
FZ (mechanical self leveling)				FZ IB+ 39-23	FZ IB+ 39-27	FZ IB+ 39-31		FZ IB+ 41-25	FZ IB+ 41-29	FZ IB+ 41-33		FZ IB+ 43-27	FZ IB+ 43-30	FZ IB+ 43-34		FZ IB+ 46-26	FZ IB+ 46-29	FZ IB+ 46-33		FZ IB+ 48-33	FZ IB+ 48-37	FZ IB+ 48-42	
FS (hydraulic self leveling)							FS IB+ 39-35				FS IB+ 41-37			FS IB+ 43-38				FS IB+ 46-37					
Suitable for tractors with kW/hp			kW hp	45-95 60-130	60-95 80-130	65-95 90-130		60-120 80-160	75-120 100-160	80-120 110-160		75-130 100-180	85-130 110-180	95-130 130-180		95-190 130-260	105-190 140-260	120-190 160-260		140-220 190-300	150-220 200-300	155-220 210-300	
Lifting force approx. in the implement's pivot point	below 1,5m above	Q1 Q2	daN daN	2300 1850 1550	2670 2140 1800	3070 2460 2060	3490 2800 2360	2510 2040 1680	2880 2340 1930	3280 2660 2200	3710 3010 2490	2660 2230 1890	3060 2530 2120	3420 2860 2430	3830 3210 2760	2580 2280 2020	2940 2600 2280	3320 2930 2590	3720 3290 3000	3320 2760 2230	3730 3100 2500	4150 3450 2790	
Lifting force (blade) approx. 300 mm before the pivot point	below 1,5m above	N1 N2	daN daN	2300 1850 1550	2670 2140 1800	3070 2460 2060	3000 2510 1970	2510 2040 1680	2880 2340 1930	3280 2660 2200	3210 2700 2110	2660 2230 1890	3060 2530 2120	3420 2860 2430	3360 2900 2330	2580 2280 2020	2940 2600 2280	3320 2930 2590	3290 2990 2565	3320 2760 2230	3730 3100 2500	4150 3450 2790	
Lifting force (pallet) approx. 800 mm before the pivot point	below 1,5m above	M1 M2	daN daN	2300 1850 1550	2670 2140 1800	3070 2460 2060	2430 2130 1545	2510 2040 1680	2880 2340 1930	3280 2660 2200	2620 2320 1680	2660 2230 1890	3060 2530 2120	3420 2860 2430	2785 2500 1840	2580 2280 2020	2940 2600 2280	3320 2930 2590	2750 2600 2060	3320 2760 2230	3730 3100 2500	4150 3450 2790	
Breakout force 800 mm before the pivot point	below	R	daN	2910	3550	3550	3080	2900	3540	3850	3540	4580	3840	4560	4140	4900							
800 mm lift height in the implement's pivot	H	mm			3850				4100				4320			4550					4800		
Overloading height (H-210)	L	mm			3640				3890				4110			4340					4590		
Dump height	A	mm			2810				3060				3290			3490					3750		
Dump width	W	mm			700				790				780			800					880		
Digging depth	S	mm			210				210				210			210					210		
Pivot point of lifting arms	B	mm			1800				1945				1945			2045					2180		
Tilt angle	X	° degree			44°				44°				44°			44°					45°		
	rescoped	X1	° degree		61°		-		61°		-		61°		-	63°					62°		
Dumping angle	above	Z	° degree		57°				57°				56°			58°					58°		
Pump output rate			l/min		75				90				90			100					120		
Lifting cylinder			mm	Ø 65 mm	Ø 70 mm	Ø 75 mm	Ø 80 mm	Ø 70 mm	Ø 75 mm	Ø 80 mm	Ø 85 mm	Ø 75 mm	Ø 80 mm	Ø 85 mm	Ø 90 mm	Ø 75 mm	Ø 80 mm	Ø 85 mm	Ø 90 mm	Ø 85 mm	Ø 90 mm	Ø 95 mm	
Stroke time			sec.	3,4	3,9	4,5	5,1	3,3	3,8	4,3	4,8	3,8	4,3	4,8	5,4	3,6	4,3	4,7	5,3	3,8	4,2	4,7	
Tilting time, implement			sec.	0,6	0,7	0,7	0,6	0,5	0,6	0,6	0,6	0,6	0,7	0,7	0,7	0,6	0,7	0,7	0,6	0,5	0,6	0,6	
Dumping time, implement			sec.	1,3	1,6	1,6	2,2	1,1	1,3	1,4	2,1	1,3	1,7	1,7	2,3	1,3	1,6	1,6	2,1	1,2	1,4	1,4	
Weight, lifting arms without implement			kg	604	610	612	575	650	657	665	615	767	770	775	710	852	860	864	790	886	890	898	

Values given are average values, depending on tractor type and loader equipment, there may be deviations upwards or downwards. The specified lifting forces are only applicable for the specified height of the swing pivot point B calculated for 195 bar hydraulic pressure.

SELF-LEVELING MODELS

FZ



Mechanic self-levelling

FS



Hydraulic self-levelling

DISPLAY



User-friendly visualized control and setting of front loader parameters via the tractor's integrated display.

This functionality may vary depending on the specific tractor model.

DIMENSIONS

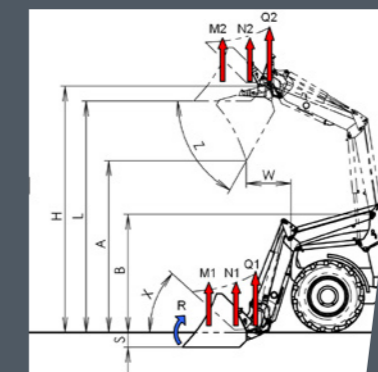

- Connected to the tractor screen
- Control linked to the tractor joystick
- All 12 functions fully accessible over one connection on the tractor interface
- New level of comfort and higher safety standards
- Electronic hydraulic parallel guidance function (only for FS front loaders)



ProfiLine ISOBUSConnected



Wilhelm STOLL Maschinenfabrik GmbH
Bahnhofstr. 21 | 38268 Lengede
Telefon: +49 (0) 53 44 / 20-222
Fax: +49 (0) 53 44 / 20-49182



www.stoll-loaders.com